

Name: Adam Drake
Date: March, 2016
Track: R/C Tracks Las Vegas

Track Conditions
 Size: Open Med. Tight
 Traction: High Med. Low
 Surface: Smooth Med. Bumpy

Result
 Race Time/Lap: _____
 Best Lap (1Lap): _____

Front Suspension

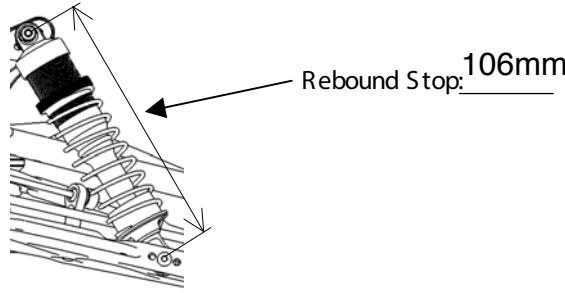

Ride Height: 37mm
 Toe Angle: 1 degree out
 Kingpin Ball Spacer (Upper): 1
 (Lower): 1
 Wheel Hub: E2214 (11.5mm)
 Anti Roll Bar: 2.6mm
 Upper Arm Spacer: 0

Upright: E2105-B
 E2129
 Tension Rod: E2107A(Long)
 E2107B(Short)

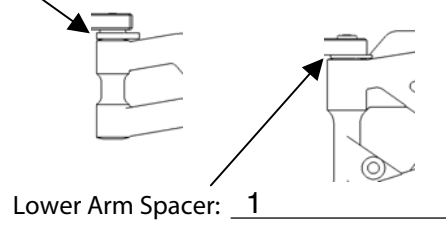
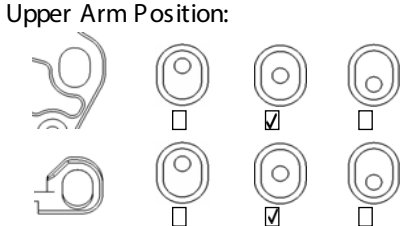

Front Shocks

Piston: 6 hole 1.3mm
 Oil: Mugen 600
 Spring: 1.5 / 7.5

Shock Position:

Pivot Ball Position: Front Rear

Rear Suspension

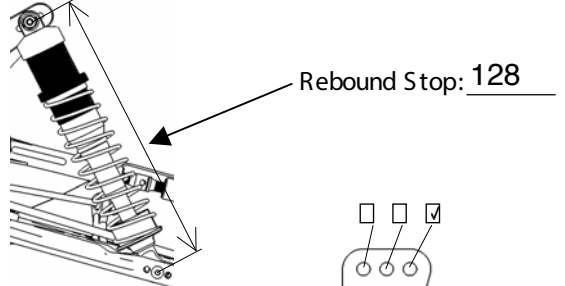

Ride Height: 38mm
 Camber Angle: -3 degrees
 Wheel Hub: E2214 (11.5mm)
 Anti Roll Bar: 2.9mm
 Lower Arm Spacer: 0

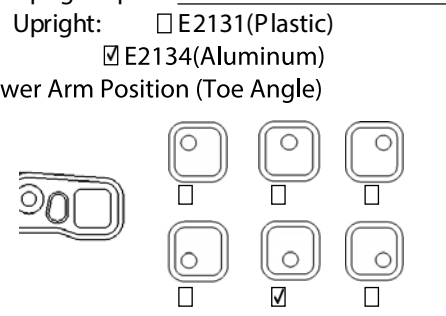
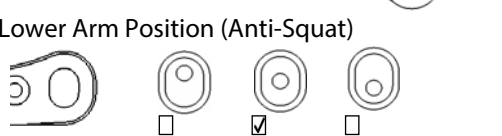
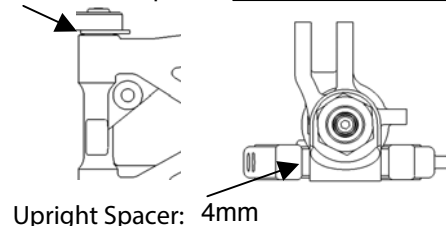
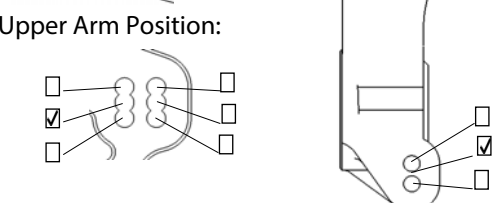

Rear Shocks

Piston: 6 hole 1.3mm
 Oil: Mugen 600
 Spring: 1.5 / 7.75

Shock Position:

Pivot Ball Position: Front Rear

Weight

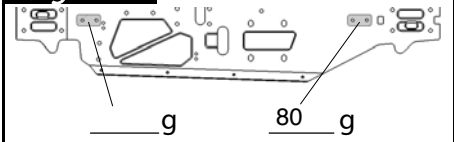

Engine

Type: Novarossi Mito 7 Plug: Novarossi C6TGC
 Gasket: _____ Reducer: 8mm
 Muffler: 9901 / 41031 Fuel: Flash Point 30%
 Engine Mount: E0701(Standard) E2701(One Piece)

Diff. Oil

Front: Mugen 20,000 O-Ring: _____ pcs.
 Center: Mugen 20,000 _____ pcs.
 Rear: Mugen 10,000 _____ pcs.

Tires

	Front	Rear
Type:	<u>Pro-Line Blockade</u>	<u>Pro-Line Blockade</u>
Compound:	<u>X1</u>	<u>X1</u>
Inserts:	<u>Pro-Line</u>	<u>Pro-Line</u>
Whed :	<u>Pro-Line</u>	<u>Pro-Line</u>

Clutch

Clutch Bell: 13T 14T
 Spur Gear: 44T 46T 48T
 Clutch Shoes: Two C0754 and one E0710
 Clutch Spring: 1.1mm

Body/ Wing

Body: Pro-Line Enforcer
 Wing: Pro-Line lexan

Wing Position:

Comments

80 grams of weight in the rear.

.....

