

**Name:** Adam Drake  
**Date:** January 2018  
**Track:** Standard set-up (Medium grip).

**Track conditions**  
 Size:  Open  Med.  Tight  
 Traction:  High  Med.  Low  
 Surface:  Smooth  Med.  Bumpy

**Result**  
 Race time / Lap: \_\_\_\_\_  
 Best lap (1Lap): \_\_\_\_\_

### Front suspension

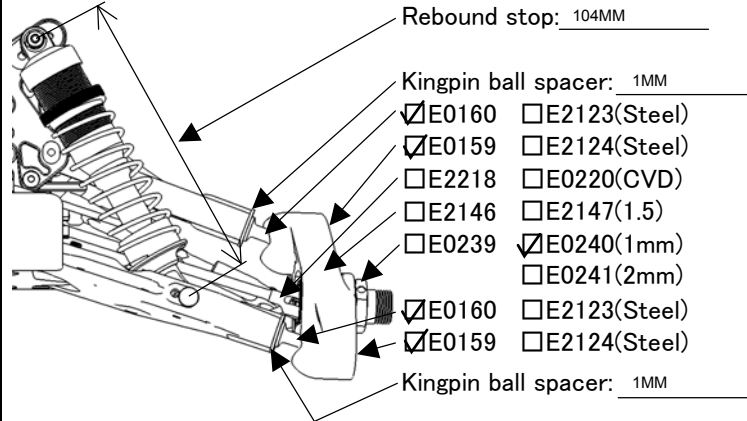

Ride height: 25MM  
 Toe angle: 1 degree out. (26.0MM)  
 Lower arm plate:  
 E2144A,B  
 E2154(CFRP 1mm)  
 E2155(CFRP 1.2mm)  
 Anti roll bar: 2.3MM  
 Upper arm spacer: 2mm  
 Lower arm spacer: 0MM

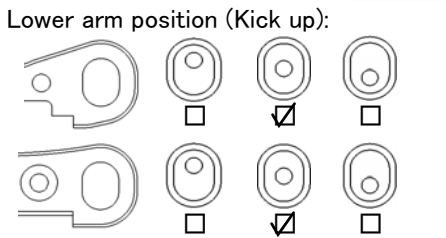
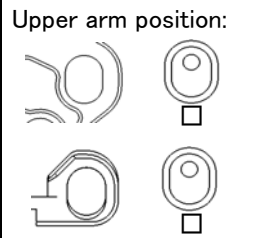

### Front shocks

Piston: 3X1.35 - 3X1.45 Oil: Mugen 600  
 Spring: 1.6 - 9.0  
 Shock position:  
  
 Pivot ball position:  Front  Rear  
 Damper stay:  E2562(Aluminum)  
 E2565(CFRP)

### Steering ackerman

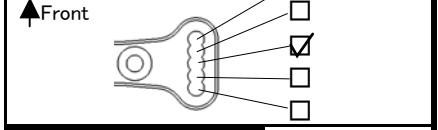

### Front upper plate

E2148D  E2158(CFRP)

### Servo saver arm

E2301A  E2310(Aluminum)

### Rear suspension

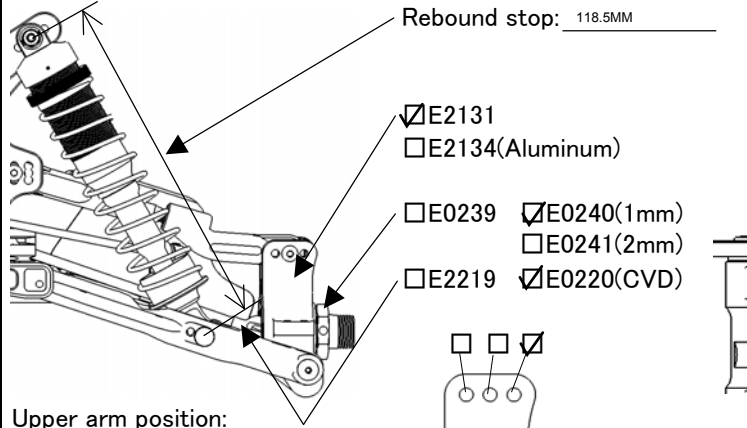

Ride height: 26MM  
 Camber angle: -2 Degrees (19.8MM)  
 Lower arm plate:  
 E2145A,B  
 E2156(CFRP 1mm)  
 E2157(CFRP 1.2mm)  
 Anti roll bar: 2.5MM  
 Lower arm spacer: 0MM  
 Upright spacer: Middle

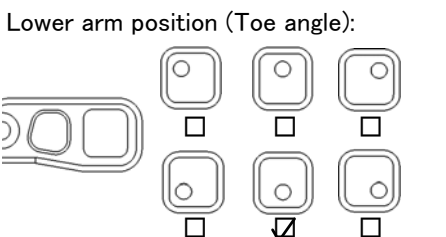
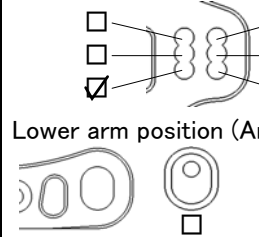

### Rear shocks

Piston: 3X1.35 - 3X1.50 Oil: Mugen 450  
 Spring: 1.6 - 10.5  
 Shock position:  
  
 Pivot ball position:  Front  Rear  
 Damper stay:  E2563(Aluminum)  
 E2566(CFRP)

### Center shaft

E0223,E0259  E2228,E2229

### Tension rod

Front:  E2107A(Long)  E2107B(Short)  
 Rear:  E2148C  E0803(Rubber)

### Weight



**Engine**  
 Type: O.S. Speed B21 Adam Drake Plug: O.S. P3 gold Reducer: 8MM  
 Muffler: O.S. 2090 with 85mm header Fuel: Flash Point 30% Gasket: Stock  
 Engine mount:  E0701(Standard)  Other

**Diff. Gear**  
 Front:  44/13T  42/12T Oil: Mugen 5,000  
 Rear:  44/13T  42/12T Mugen 3,000  
 Center:  44T  46T Mugen 7,000  
 47T  48T

**Tires**

	Front	Rear
Type:	Pro-Line Holeshot 2.0	Pro-Line Holeshot 2.0
Compound:	X3	X3
Inserts:	Pro-Line	Pro-Line
Wheel:	Pro-Line	Pro-Line

**Clutch**  3P  4P  
 Clutch bell:  13T  14T  
 Clutch shoes  C0754  E0704  E0710  E2706  
 Clutch spring  0.8  0.9  0.95  1.0  1.05  1.1

### Body/Wing

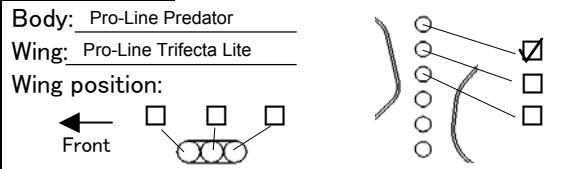

### Comments

.....  
 .....  
 .....